

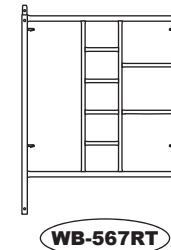

A-1 SCAFFOLD MFG., INC.

590 Commerce Parkway | Hays, KS 67601
 Ph 785.621.5121 | Fax 785.621.5122
 www.a1scaffoldingmfg.com

WB Series Scaffold

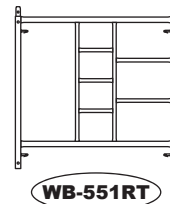
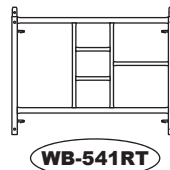
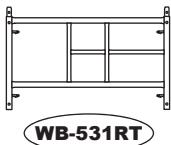
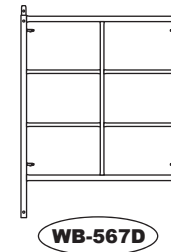
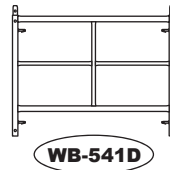
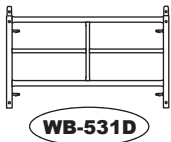
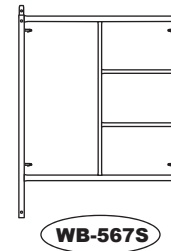
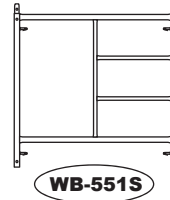
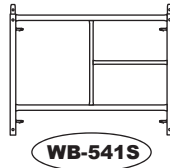
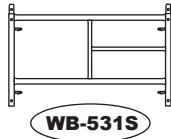
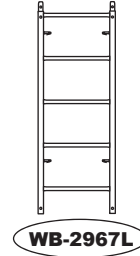
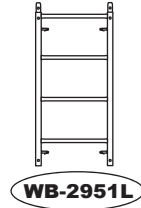

Specifications

Part Number	Description	Weight (lbs.)
Ladder Frames		
WB-2931L	29" x 3'1" Ladder	20.0
WB-2941L	29" x 4'1" Ladder	23.0
WB-2951L	29" x 5'1" Ladder	29.0
WB-2967L	29" x 6'7" Ladder	36.0
WB-331L	3' x 3'1" Ladder	19.0
WB-341L	3' x 4'1" Ladder	25.0
WB-351L	3' x 5'1" Ladder	32.0
WB-367L	3' x 6'7" Ladder	35.6
Single Ladder Frames		
WB-521S	5' x 2' 1" Single Ladder	24.0
WB-531S	5' x 2' 1" Single Ladder	27.0
WB-541S	5' x 4' 1" Single Ladder	31.0
WB-551S	5' x 6' 7" Single Ladder	37.0
WB-567S	5' x 6' 7" Single Ladder	41.3

Part Number	Description	Weight (lbs.)
Double Ladder Frames		
WB-531D	5' x 3' 1" Double Ladder	31.0
WB-541D	5' x 4' 1" Double Ladder	33.0
WB-551D	5' x 5' 1" Double Ladder	41.0
WB-567D	5' x 6' 7" Double Ladder	45.3
Rolling Tower Frames		
WB-531RT	5' x 3' 1" Rolling Tower	37.2
WB-541RT	5' x 4' 1" Rolling Tower	40.8
WB-551RT	5' x 5' 1" Rolling Tower	49.5
WB-567RT	5' x 6' 7" Rolling Tower	57.3

1 5/8" Dia. Tube
 Holes at 90°
 D Locks

Frames

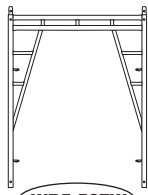

WB5-567W

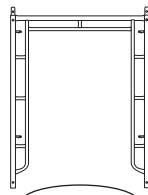

WB6-567W

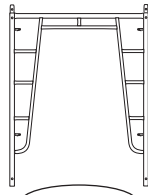

WB7-567W

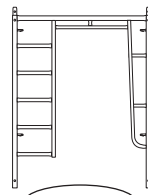

WB-567WL

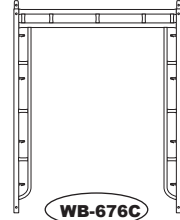

WB-676C

Specifications

Part Number	Description	Weight (lbs.)
Walk Thru Frames		
WB-351W	3' x 5' 1" Walk Thru	32.0
WB-367W	3' x 6' 7" Walk Thru	35.6
WB-551W	5' x 5' 1" Walk Thru	40.0
WB5-567W	5' x 6' 7" Walk Thru	48.0
WB6-567W	5' x 6' 7" Walk Thru	55.0
WB7-567W	5' x 6' 7" Walk Thru	50.0

Part Number	Description	Weight (lbs.)
Walk Thru Ladder		
WB-567WL	5' x 6' 7" Walk Thru Ldr	53.5
Canopy Frame		
WB-676C	6' x 7' 6" Canopy Frame	66.0

1 5/8" Dia. Tube
Holes at 90°
D Locks

Accessories

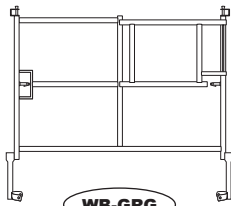

WB-GRG

WB-GRP

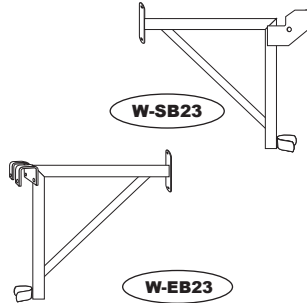

W-SB23

W-EB23

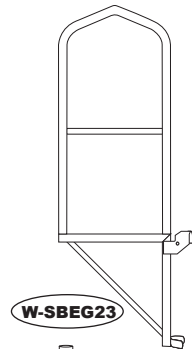

W-SBEG23

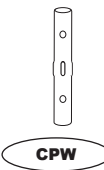

CPW

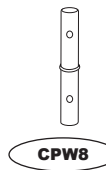

CPW8



WB-SP

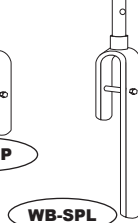

WB-SPL



SR

Specifications

Part Number	Description	Weight (lbs.)
Guard Rail		
WB-GRG	5' Guard Rail Gate	45.0
WB-GRP	Guard Rail Post	7.0

Side & End Brackets		
W-SB20	20" Side Bracket	9.0
W-SB23	23" Side Bracket	11.5
W-SB30	30" Side Bracket	13.0
W-EB20	20" End Bracket	9.0
W-EB23	23" End Bracket	11.5
W-SBEG20	20" Side Bracket End Guard	15.0
W-SBEG23	23" Side Bracket End Guard	16.0

Pins		
CPW	1 5/16" Coupling Pin w/o Collar	.5
CPW8	1 5/16" Coupling Pin w/ 1/8" Collar	.5
WB-SP	Saddle Pin	2.5
WB-SPL	Saddle Pin w/ Long Leg	3.0
SR	Spring Retainer	.03

Frame Lock Styles

